

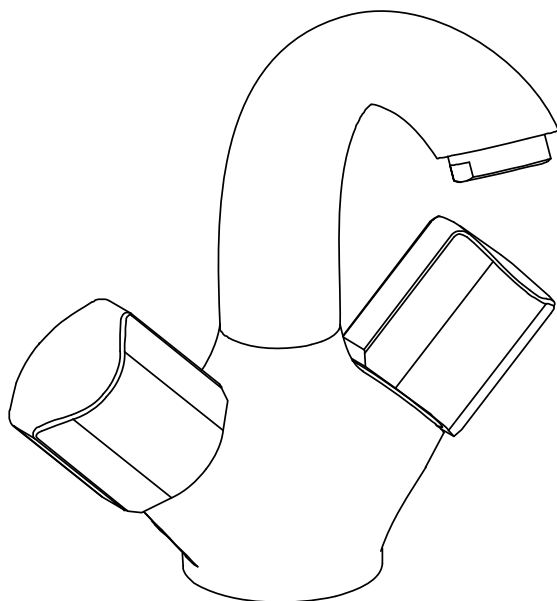

GARA

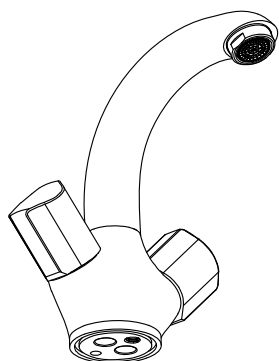

RU Руководство по сборке и эксплуатации

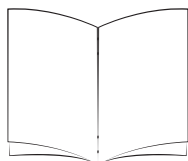

EU: 3/8" - 12/17; RU+BR: 1/2" - 15/21

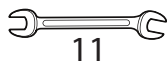
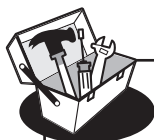
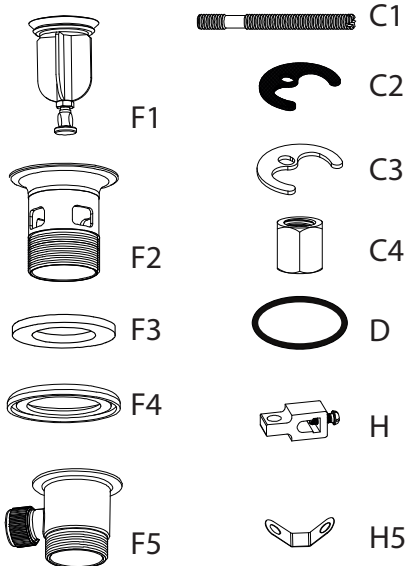
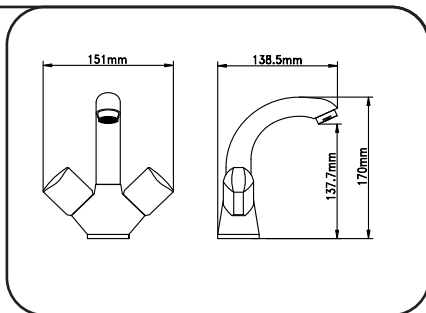
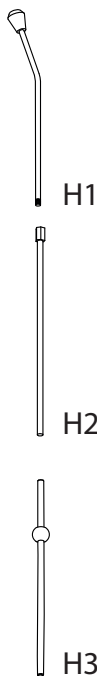

11

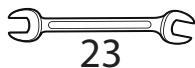

23

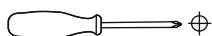

1

1

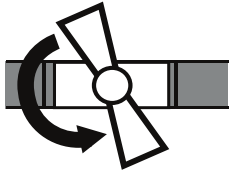

2

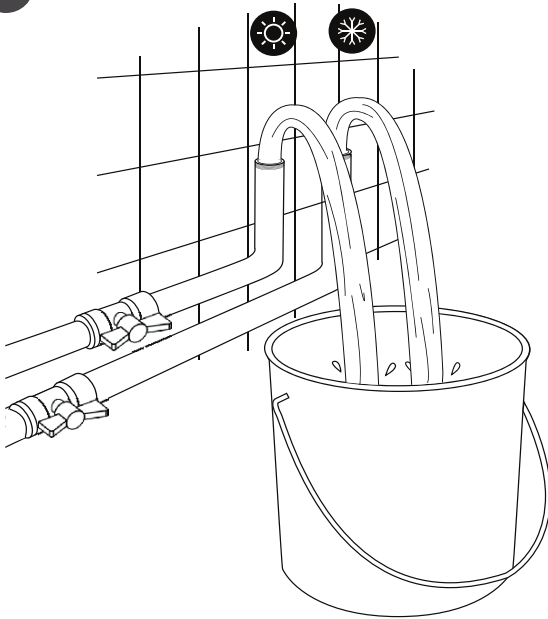

3

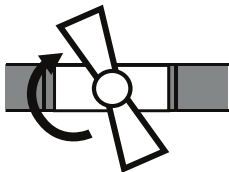

2

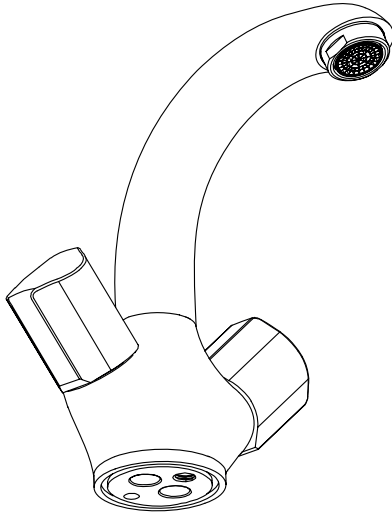

C1

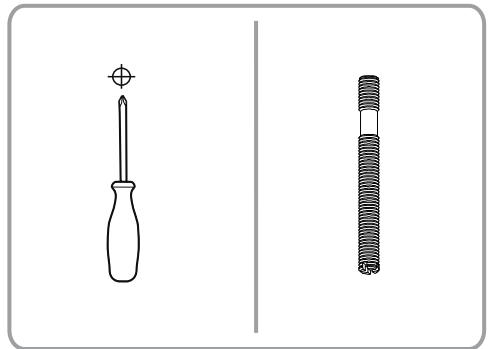

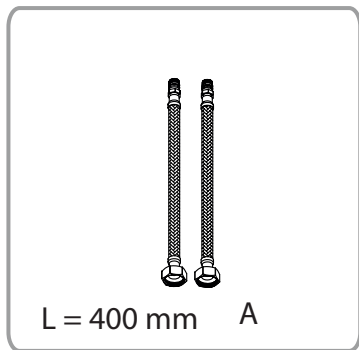
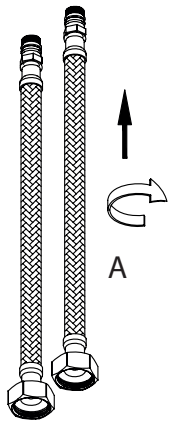
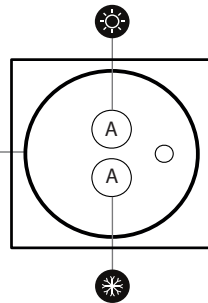
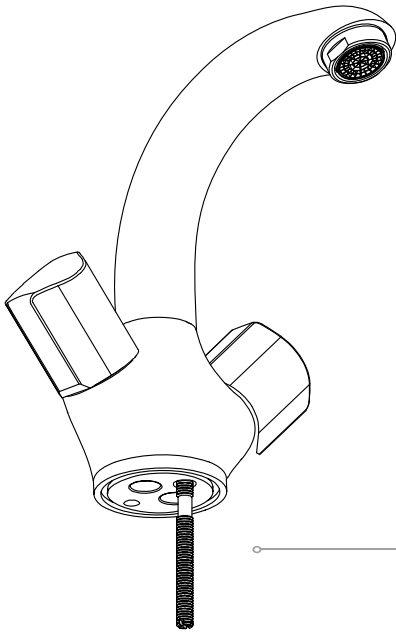

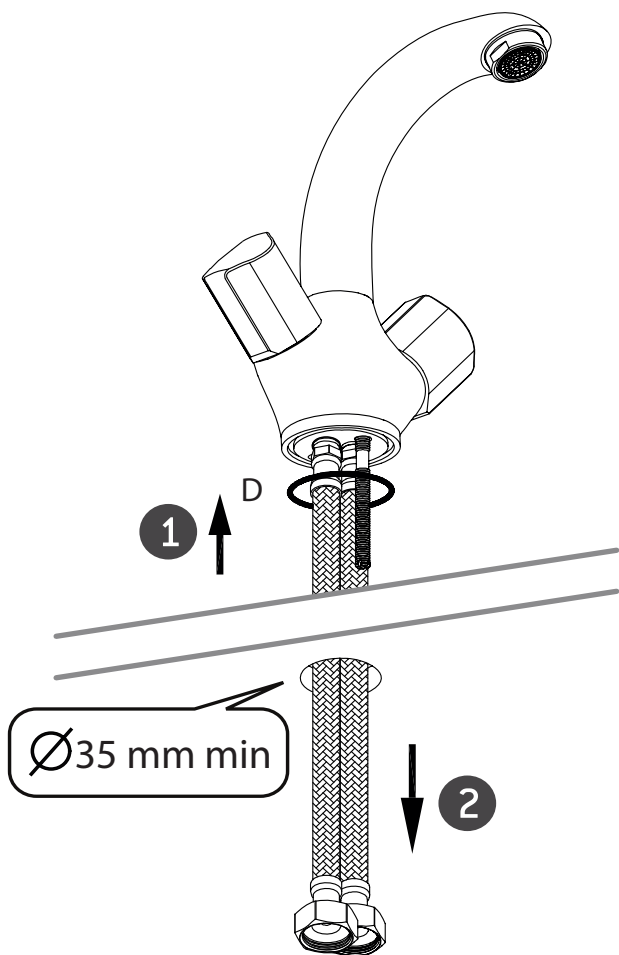

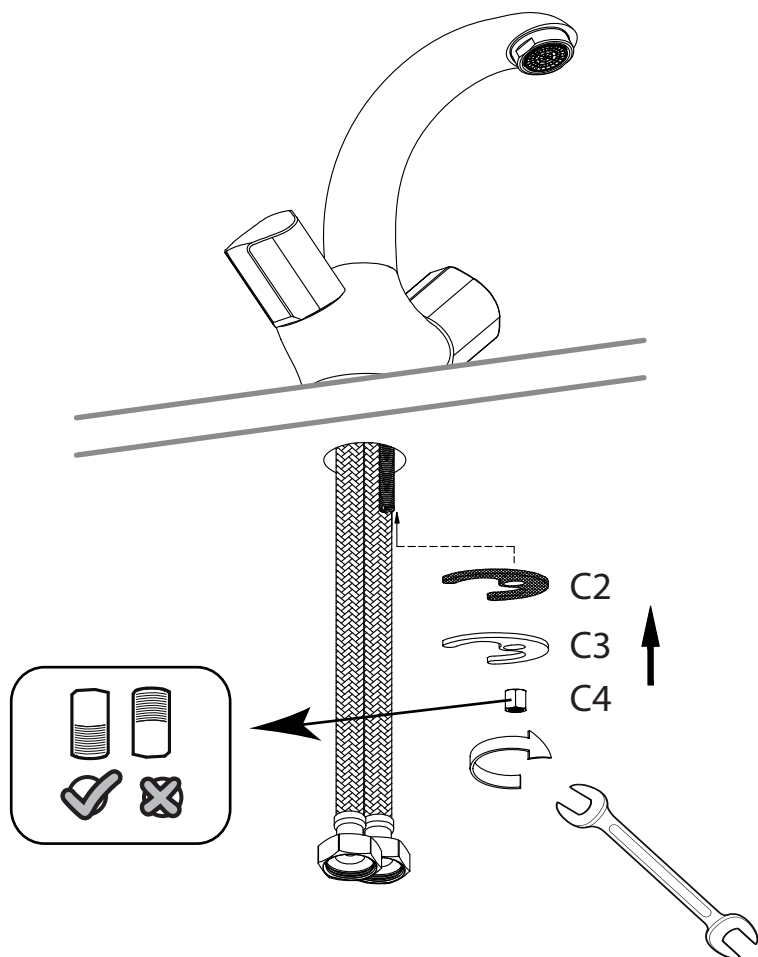



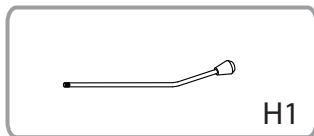
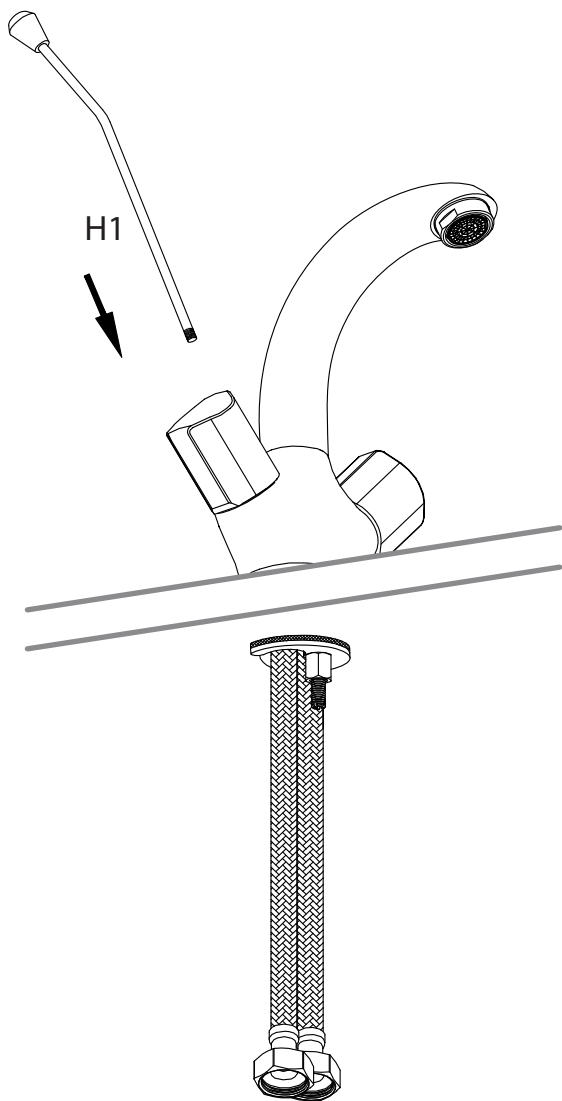







6



- FR**  **CONSEILS D'UTILISATION**
Avant la première utilisation de votre robinetterie ou après une longue période d'inutilisation, faites couler l'eau pendant quelques minutes afin de rincer le circuit d'alimentation du robinet.
- ES**  **CONSEJOS DE UTILIZACIÓN**
Antes de utilizar la grifería por primera vez, o tras una largo periodo sin uso, deje correr el agua durante varios minutos para que se limpie el circuito de alimentación del grifo.
- PT**  **CONSELHOS DE UTILIZAÇÃO**
Antes da primeira utilização das suas torneiras ou depois de um longo período sem utilização, deixe correr a água durante alguns minutos para limpar o circuito de alimentação da torneira.
- IT**  **ISTRUZIONI D'USO**
Prima di utilizzare per la prima volta la rubinetteria o dopo un periodo prolungato di inutilizzo, far scorrere l'acqua per qualche minuto, al fine di risciacquare il circuito di alimentazione del rubinetto.
- EL**  **ΟΔΗΓΙΕΣ ΧΡΗΣΗΣ**
Προτού χρησιμοποιήσετε τα υδραυλικά εξαρτήματα για πρώτη φορά ή μετά από μια μεγάλη περίοδο αχρηστίας, αφήστε το νερό να τρέξει για λίγα λεπτά για να ξεπλυθεί το σύστημα παροχής της βρύσης.
- PL**  **WSKAZÓWKI DOTYCZĄCE UŻYCIA**
Przed pierwszym użyciem kranu lub po długim czasie jego nieużywania należy odkręcić wodę na kilka minut, aby przepłukać obieg zasilający kranu.
- RU**  **СОВЕТЫ ПО ИСПОЛЬЗОВАНИЮ**
Перед первым использованием водопроводной арматуры или после долгого периода неиспользования включите подачу воды на несколько минут, чтобы промыть канал подачи крана.
- UK**  **ПОРАДИ ЩОДО ВИКОРИСТАННЯ**
Перед першим використанням водопровідної арматури або після тривалого періоду невикористання ввімкніть подачу води на кілька хвилин, щоб промити канал подачі крана.
- RO**  **SFATURI PRIVIND UTILIZAREA**
Înainte de prima utilizare a armăturilor sau după o lungă perioadă de neutilizare, lăsați apa să curgă câteva minute pentru a curăța circuitul de alimentare a robinetului.
- EN**  **RECOMMENDATIONS FOR USE**
Before first using your mixer or after a long period of without using, run the water for a few minutes to flush the water supply pipes.