

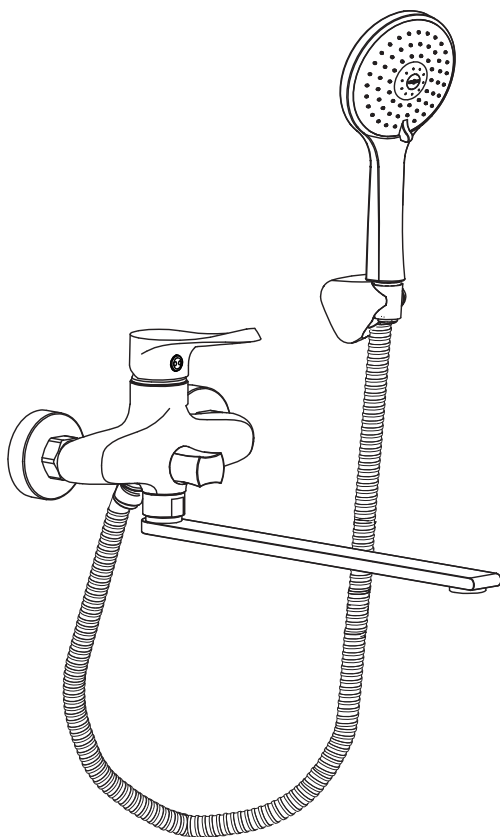

POLLY

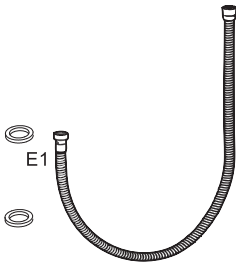

RU Руководство по сборке и эксплуатации

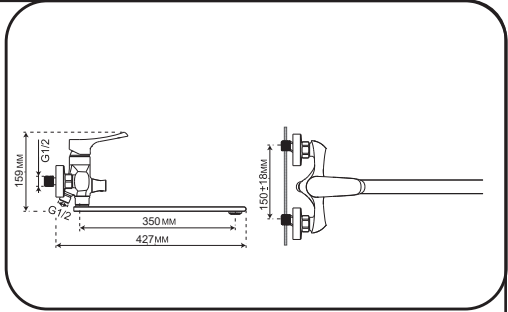
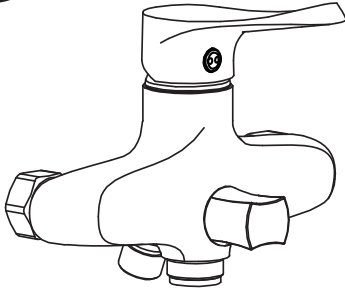

E2

E3

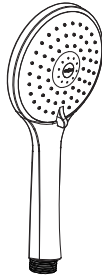

E4

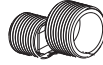
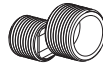

A1

B1

B2

F1

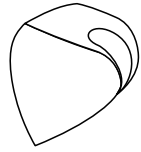

D1

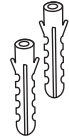

D2

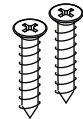

D3



C1

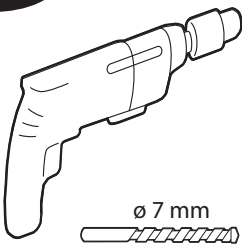
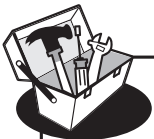
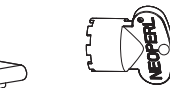

ø 7 mm

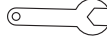

1 Подготовка к монтажу

1

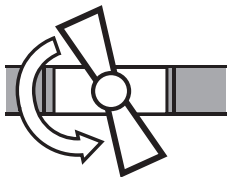

ON



15''

max.

2



3

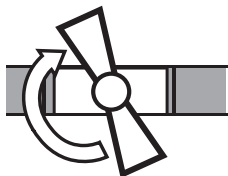

OFF



2 Установка излива

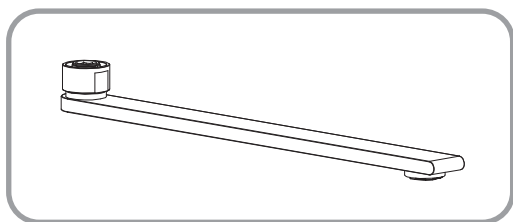
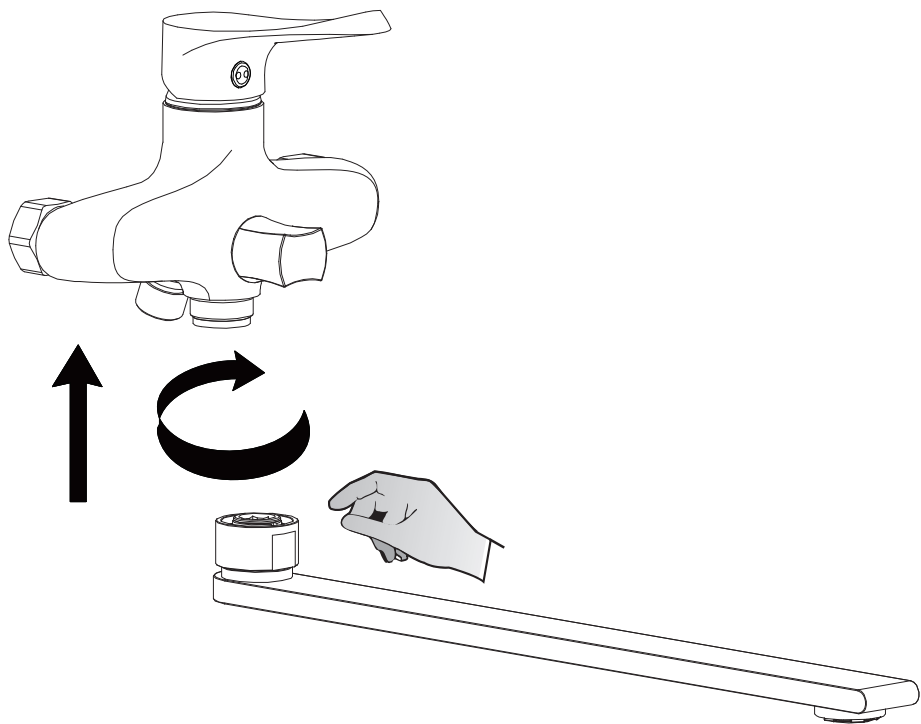

3 Установка шланга лейки

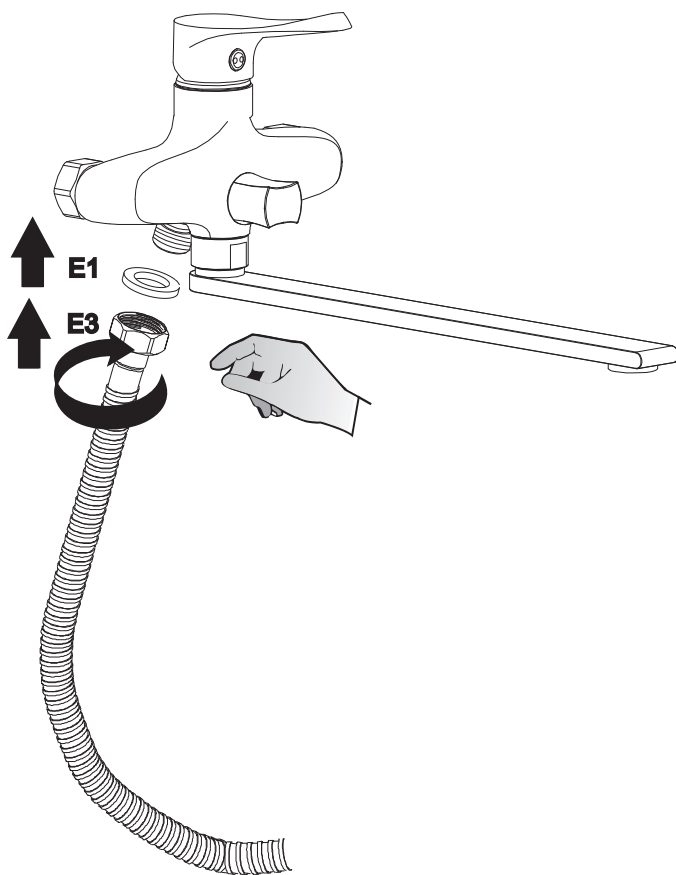

 E1

 E3

4 Установка эксцентров

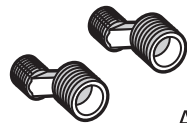
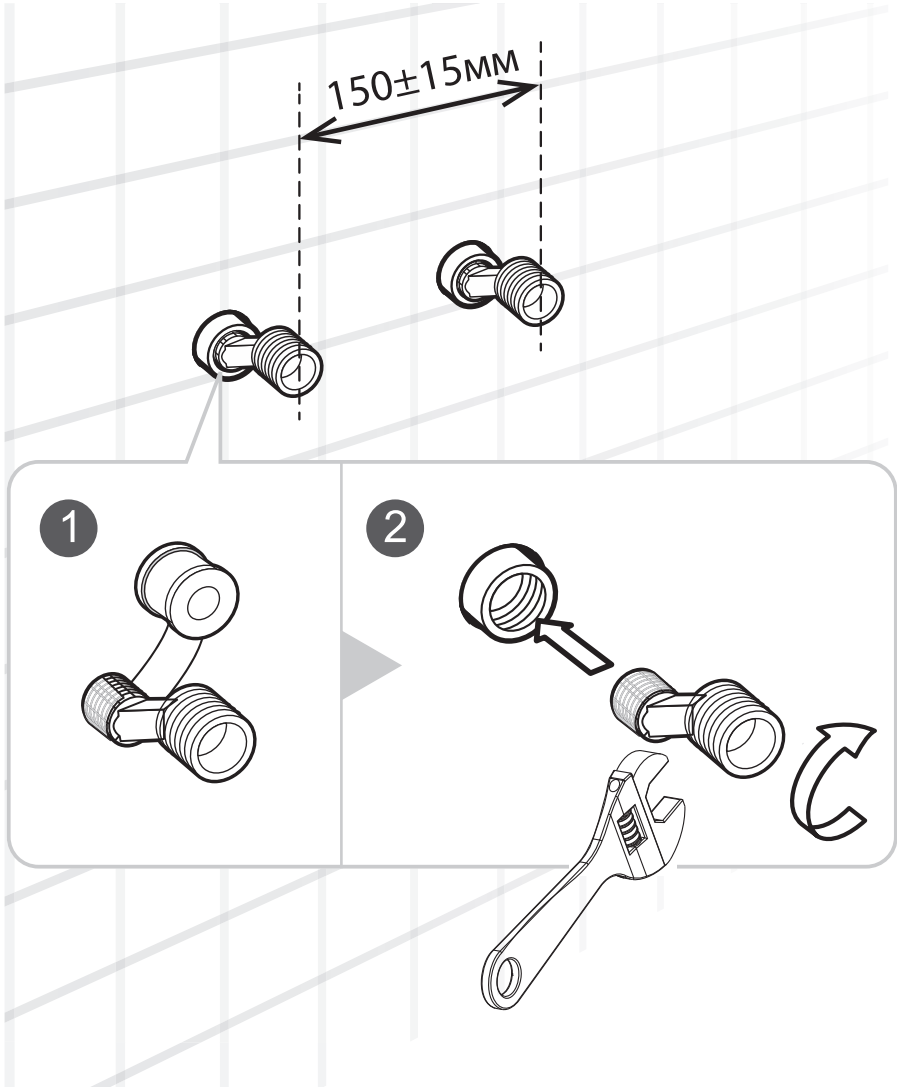

A1

5 Установка отражателей

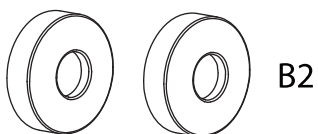
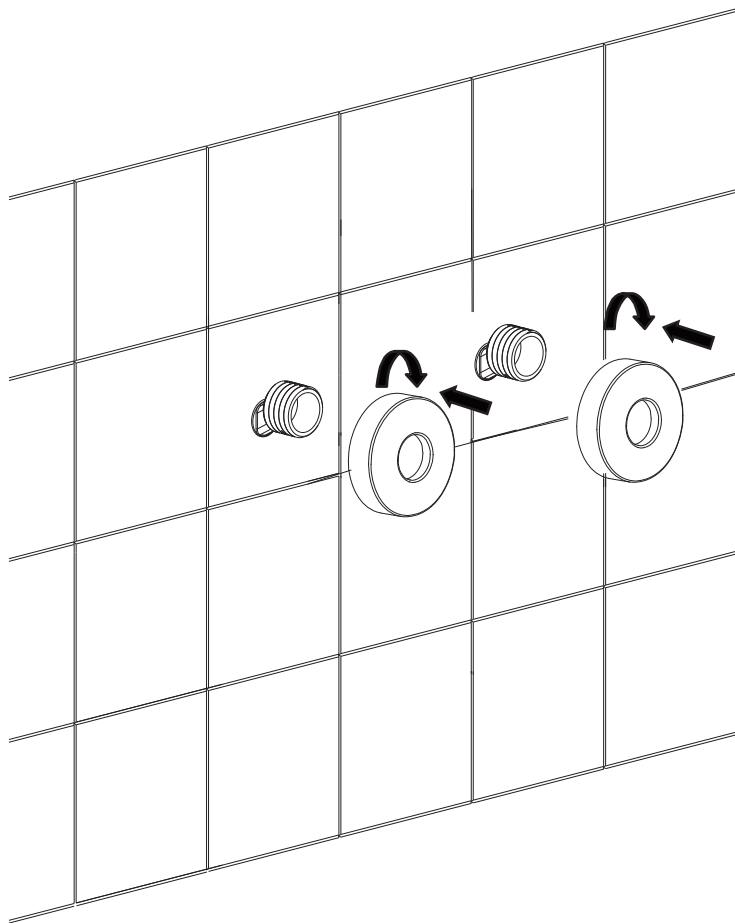

6 Установка смесителя

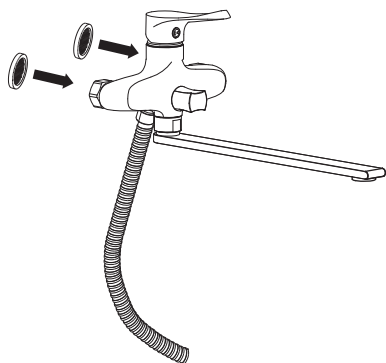

1

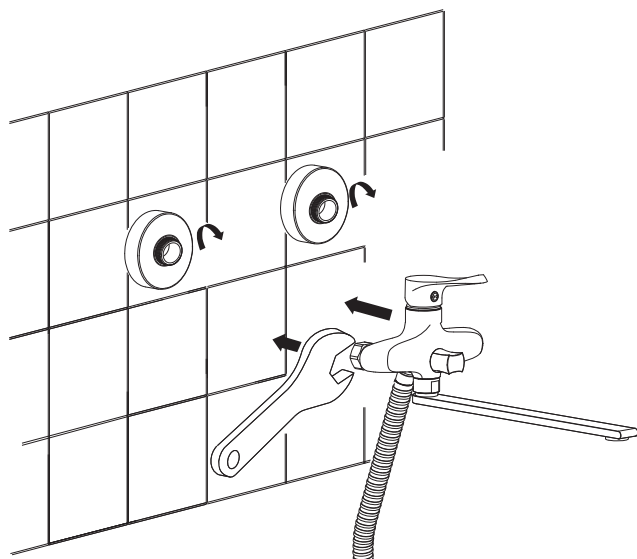

2



Ключ пластиковый 30,5 мм

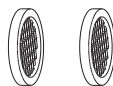

B1

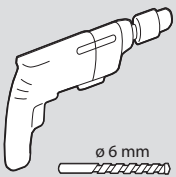
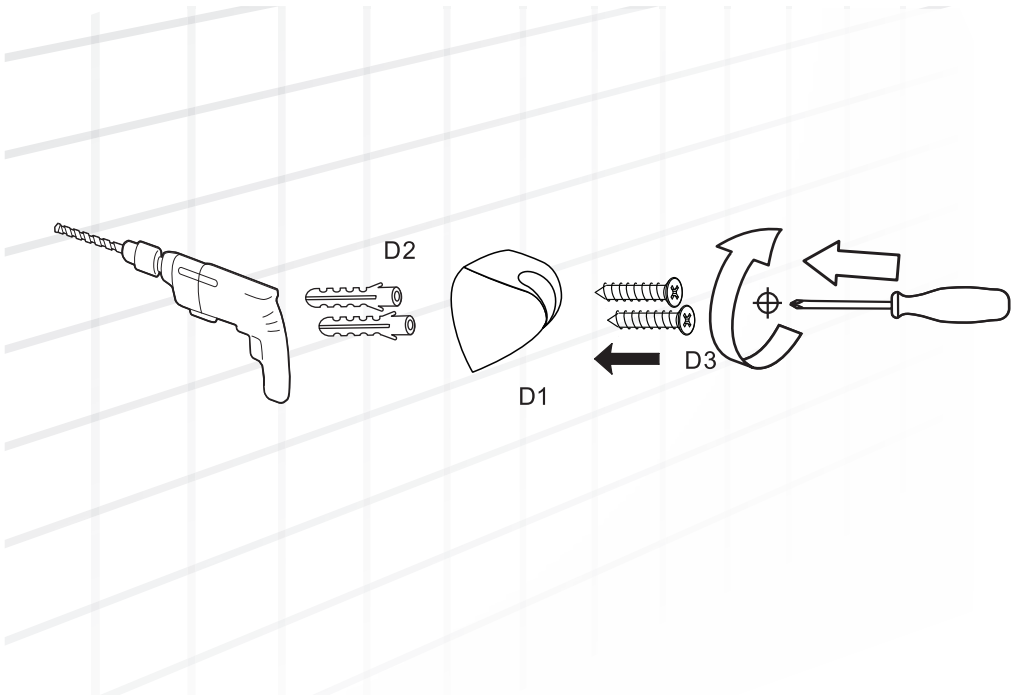

D1

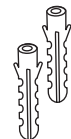

D2

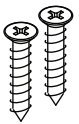

D3

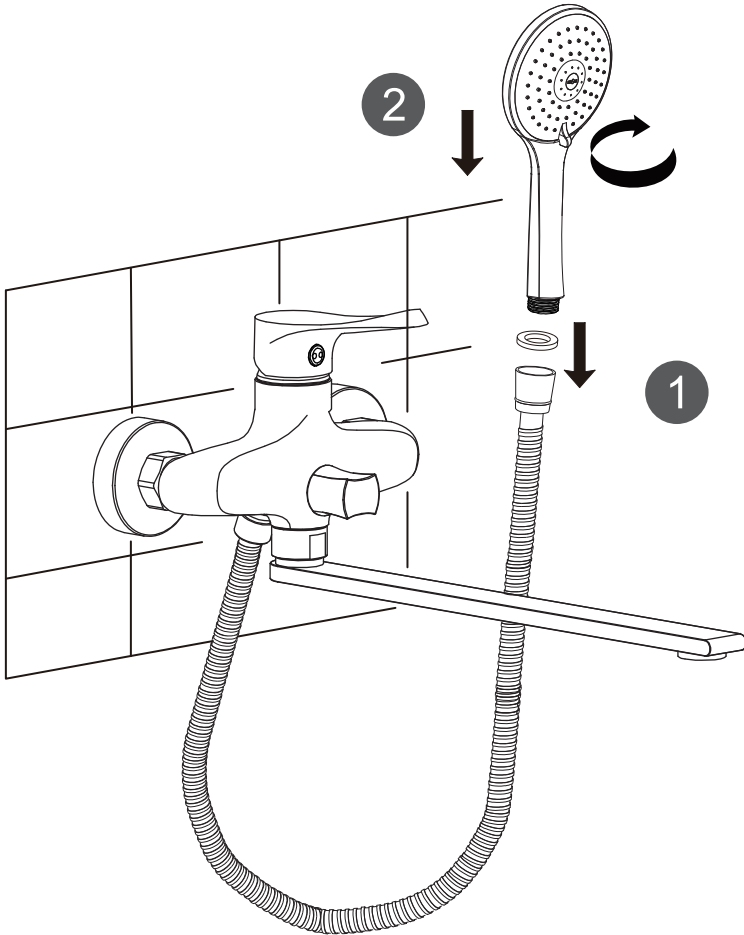

3

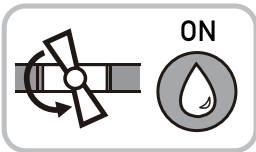

E2



E4

RU

⚠ СОВЕТЫ ПО ИСПОЛЬЗОВАНИЮ

Перед первым использованием водопроводной арматуры или после долгого периода неиспользования включите подачу воды на несколько минут, чтобы промыть канал подачи крана.

UK

⚠ ПОРАДИ ЩОДО ВИКОРИСТАННЯ

Перед першим використанням водопровідної арматури або після тривалого періоду невикористання ввімкніть подачу води на кілька хвилин, щоб промити канал подачі крана.