

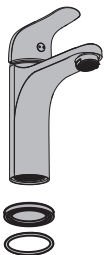

Гарантия  
**5**  
лет\*

ESTER



M10X1

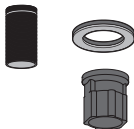
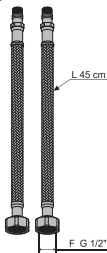

EAN CODE: 3276007035308

**RU** Руководство по  
**BY** Эксплуатации

**KZ** Пайдалану жөніндегі  
басшылық

**EN** Instructions Manual

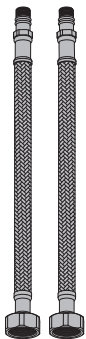
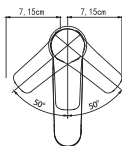
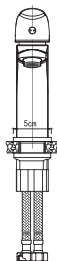
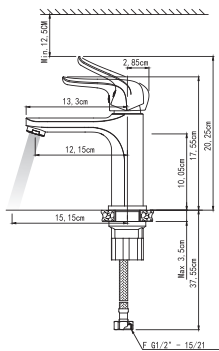

D



A



B



C



E



F



G



MIN. 35 mm





**RU/BY:** Подготовка / **KZ:** Дайындау / **EN:** Preparation



4



**RU/BY:** Сборка / **KZ:** Құрастыру / **EN:** Assembly



5 → 7



**RU/BY:** Использование горячей и холодной воды/  
**KZ:** Суық және ыстық суды қолдану/ **EN:** Using hot and cold water



8

**RU/BY:** Смена картриджа/ **KZ:** Картриджді ауыстыру/ **EN:** Replacing the cartridge



9 → 12

**RU/BY:** Смена аэратора/ **KZ:** Аэратор ауыстыру/ **EN:** Replacing the aerator



13

**RU/BY:** Смена гибкого шланга для смесителя/

**KZ:** Қоспалауышқа арналған иілгіш шлангты ауыстыру/ **EN:** Replacing the hoses



14 → 15



RU/ВУ: Подготовка / KZ: Дайындау / EN: Preparation

1

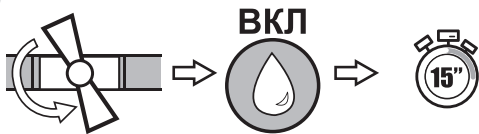

2

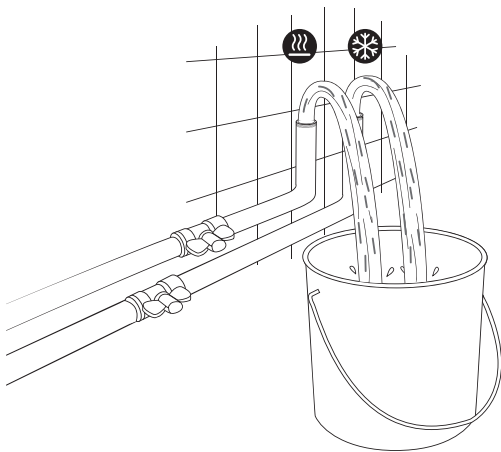

3

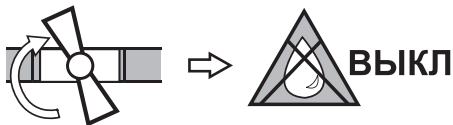

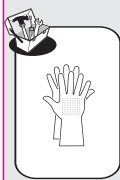
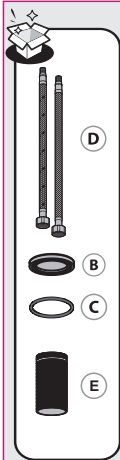

RU/БҮ: Сборка / KZ: Құрастыру / EN: Assembly

1

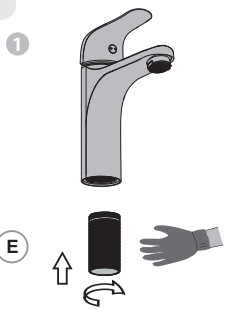

3

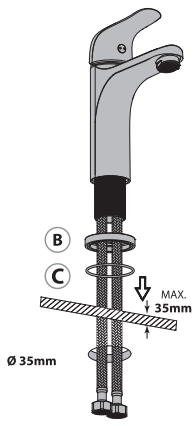

2

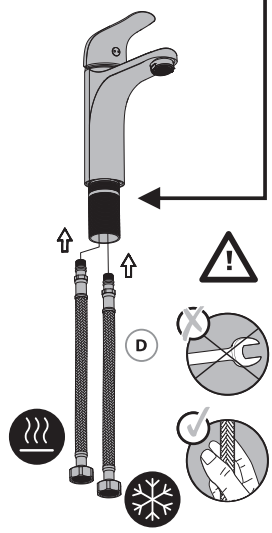
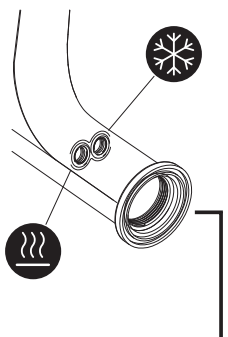



E



F



2

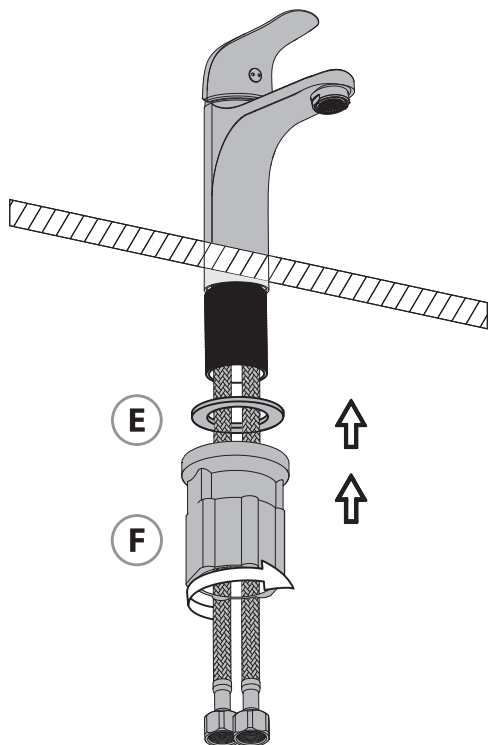

E

F



3

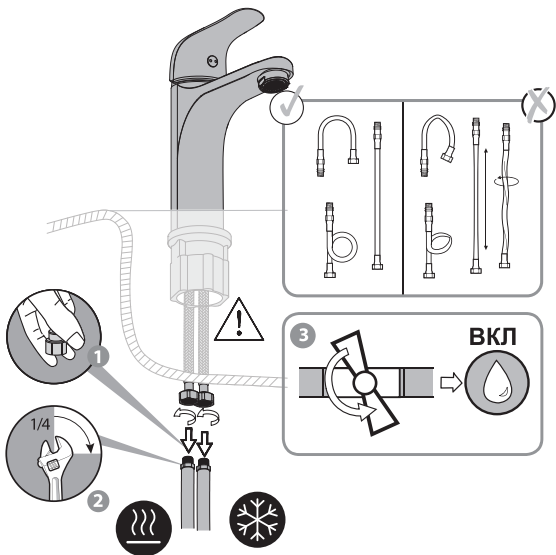



**RU/ВУ:**Использование горячей и холодной воды/  
**KZ:** Суық және ыстық суды қолдану/ **EN:** Using hot and cold water

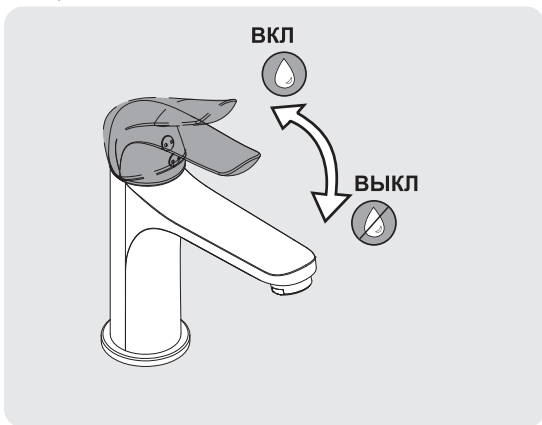



No./Номер/Нөмір	Description/Описание/Сипаттама	Code No./Номер кода/Код нөмірі	QTY/Кол-во/Мөлшері
1	Handle/Ручка/Тұтқа	H6837	1
2	Cartridge/Картридж/Картридж	35H-10	1
3	Fixing part/Крепеж/Бекіту бөлігі	41204800300	1
4	Neoperl/Аэратор/Аэратор	02.1340.0.0001	1
5	Inlet hose/Гибкий шланг/Кіріс шланг	21450300303	2

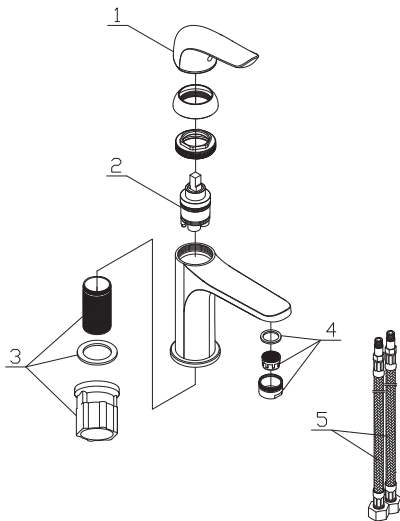

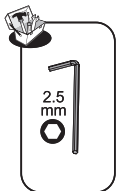

**RU/BY:** Смена картриджа/ **KZ:** Картриджді ауыстыру/  
**EN:** Replacing the cartridge

1



**ВЫКЛ**

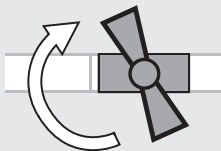

2

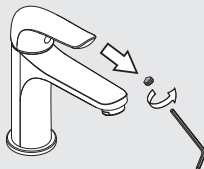

3

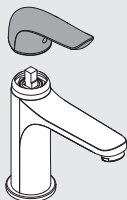

4

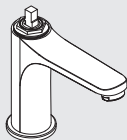

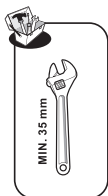

**RU/BY:** Смена картриджа/ **KZ:** Картриджді ауыстыру/  
**EN:** Replacing the cartridge

5

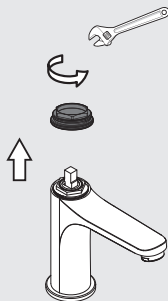

6

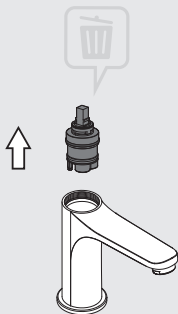

7

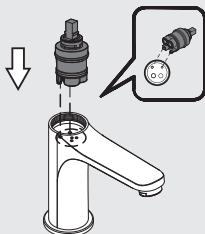

8

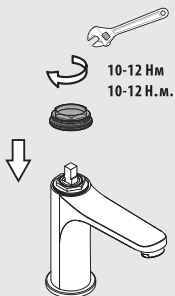



RU/BY: Смена картриджа/ KZ: Картриджді ауыстыру/  
EN: Replacing the cartridge

9

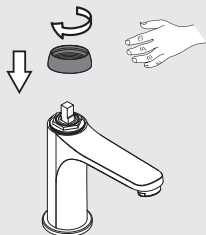

10

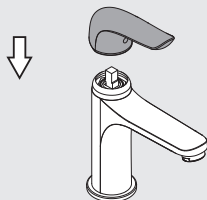

11

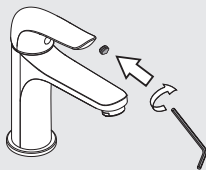

12

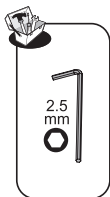

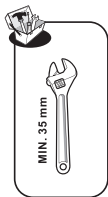

RU/БҮ: Смена аэратора/ KZ: Аэратор ауыстыру/ EN: Replacing the aerator

1

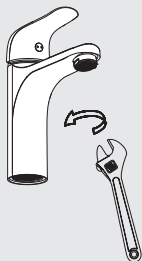

2

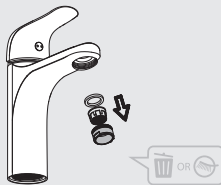

RU/БҮ Чистка KZ тазарту EN Cleaning



3

RU Уксус KZ Сірке су EN Vinegar

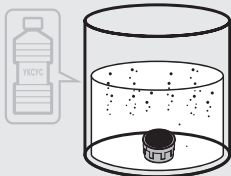

4

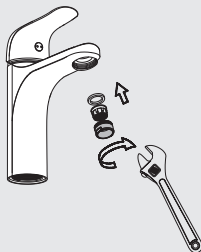

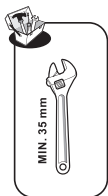

**RU/ВУ:** Смена гибкого шланга для смесителя/  
**KZ:** Қоспалауышқа арналған иілгіш шлангты ауыстыру/ **EN:** Replacing the hoses

1



**ВЫКЛ**

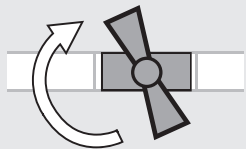

2

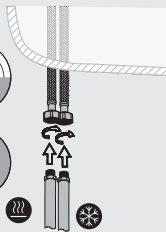

3

**ВКЛ**

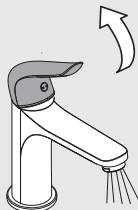

4

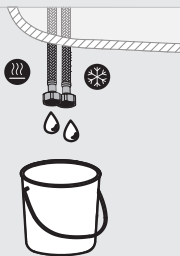

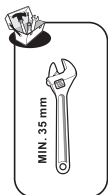

**RU/BY:** Смена гибкого шланга для смесителя/  
**KZ:** Қоспалауышқа арналған иілгіш шлангты ауыстыру/ **EN:** Replacing the hoses

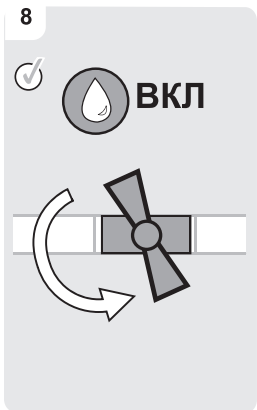
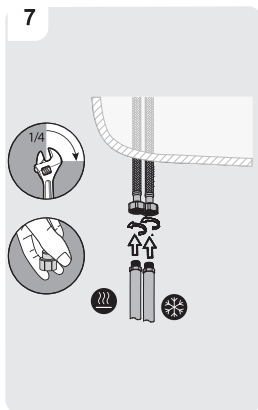
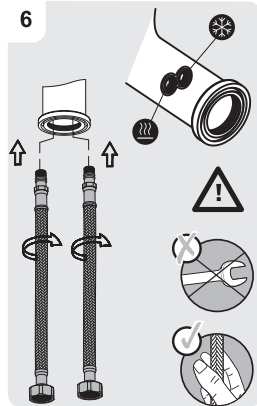
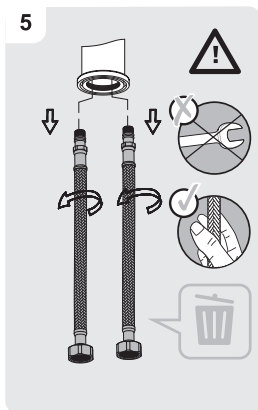



Чистая вода / Таза су / Clean water



Без розчинителя / Еріткішсіз / Solvent-free

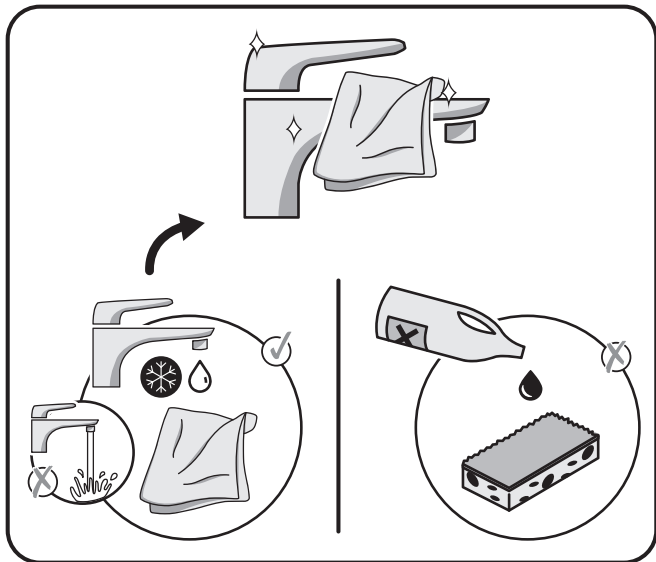











Декларация о соответствии санитарным нормам  
Санитарлық талаптарға сәйкестік декларациясы  
Declaration of sanitary conformity.

\* Кепілдік 5 жыл / Гарантия 5 лет / 5-year guarantee

Made in P.R.C. 2019

**FR** ADEO Services - 135 Rue Sadi Carnot - CS 00001  
59790 RONCHIN - France

**UA** ТОВ «Леруа Мерлен Україна»,  
вул. Полянка 17а, м. Київ 04201, Україна

**RU** ООО ЛЕРУА МЕРЛЕН ВОСТОК, 141031, Московская  
область, г. Мытищи, Осташковское шоссе, д.1, РОССИЯ

**BY** ООО «Леруа Мерлен Бел», 220020, Республика Беларусь,  
город Минск, проспект Победителей, 100, офис 503

**KZ** Қазақстан Республикасында өнім сапасы бойынша  
наразылықтарды қабылдауға уәкілетті ұйым: «Леруа Мерлен  
Қазақстан» ЖШС, Қазақстан Республикасы, 050000,  
Алматы қ., Қонаев көшесі, 77, «PARKVIEW» БО, 6-қабат, 07-кеңсе.  
Организация, уполномоченная принимать претензии по  
качеству продукции в Республике Казахстан: ТОО «Леруа  
Мерлен Казахстан», Республика Казахстан, 050000, г. Алматы,  
ул. Куняева, 77, БЦ «ParkView», 6 этаж, офис №07.

