

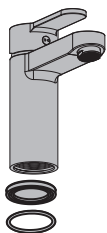

Гарантия  
**5**  
лет\*

HARMONY



M10X1

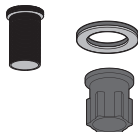
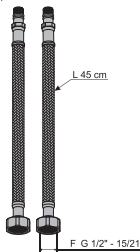

EAN CODE: 3276007035452

**RU** Руководство по  
**BY** Эксплуатации

**KZ** Пайдалану жөніндегі  
басшылық

**EN** Instructions Manual

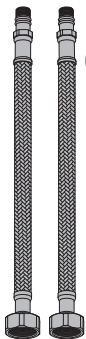
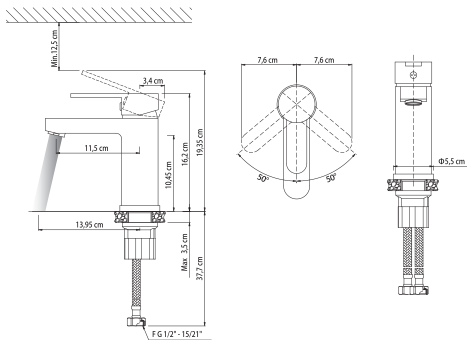

D

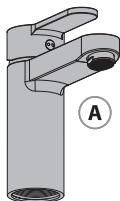

A



B



C



E



F



G



MIN. 35 mm





**RU/BY:** Подготовка / **KZ:** Дайындау / **EN:** Preparation



4



**RU/BY:** Сборка / **KZ:** Құрастыру / **EN:** Assembly



5 → 7



**RU/BY:** Использование горячей и холодной воды/  
**KZ:** Суық және ыстық суды қолдану / **EN:** Using hot and cold water



8

**RU/BY:** Смена картриджа / **KZ:** Картриджді ауыстыру / **EN:** Replacing the cartridge



9 → 12

**RU/BY:** Смена аэратора / **KZ:** Аэратор ауыстыру / **EN:** Replacing the aerator



13

**RU/BY:** Смена гибкого шланга для смесителя /

**KZ:** Қоспалауышқа арналған иілгіш шлангты ауыстыру / **EN:** Replacing the hoses



14 → 15



RU/ВУ: Подготовка / KZ: Дайындау / EN: Preparation

1

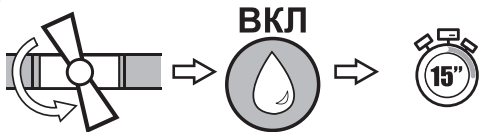

2

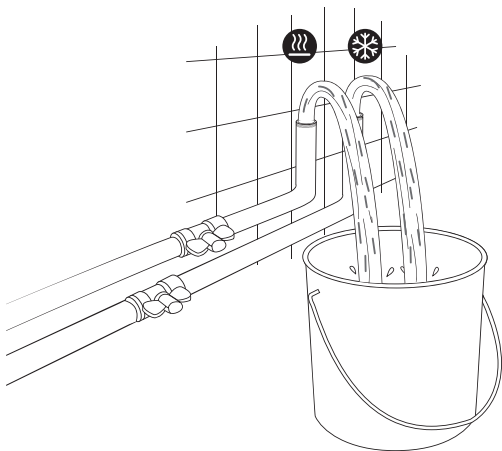

3

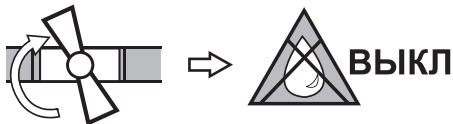

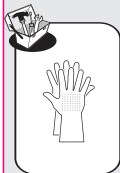
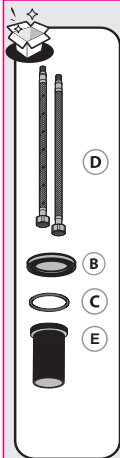

RU/БҮ: Сборка / KZ: Құрастыру / EN: Assembly

1

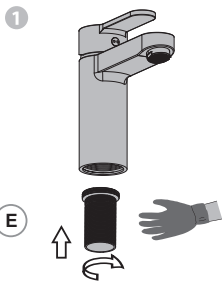

E

3

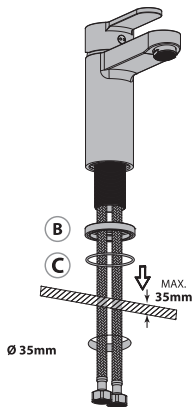

B

C

MAX.  
35mm

$\varnothing 35\text{mm}$

2

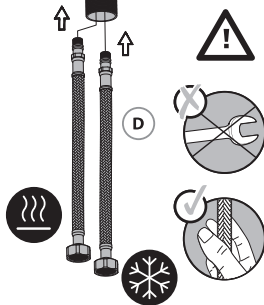
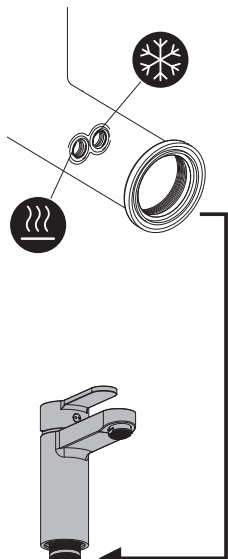

D

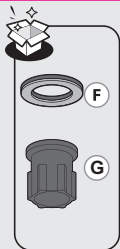

2

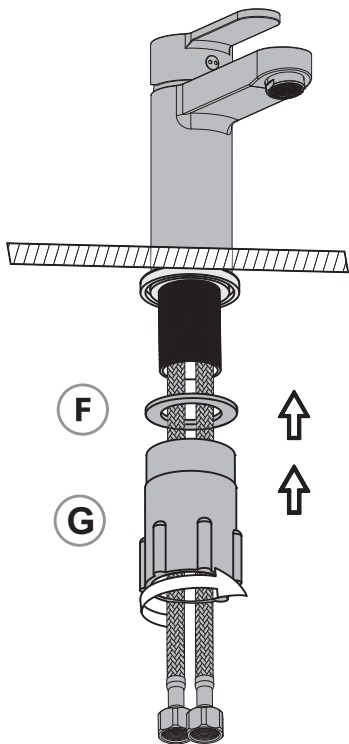

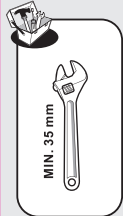

3

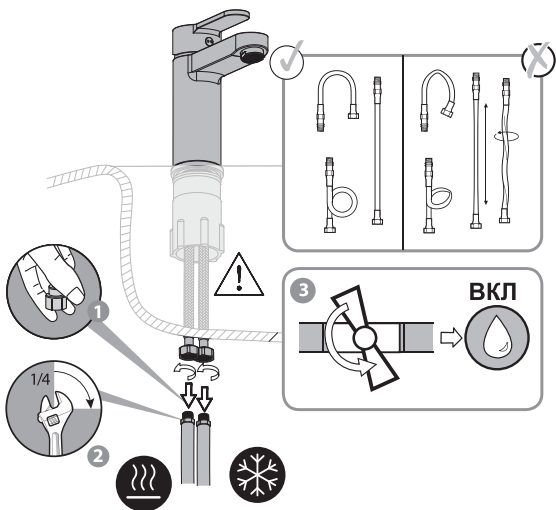



**RU/УУ:**Использование горячей и холодной воды/  
**KZ:** Суық және ыстық суды қолдану/ **EN:** Using hot and cold water

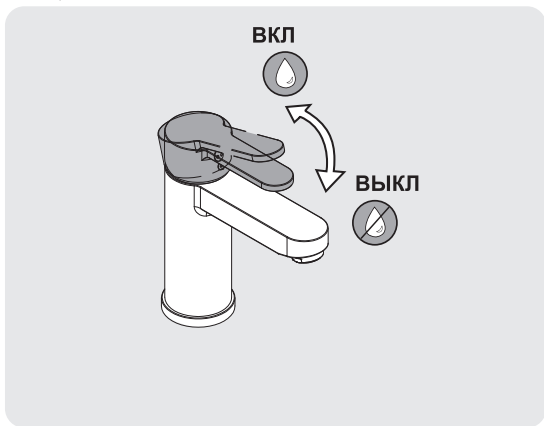



| No./Номер/Нөмір | Description/Описание/Сипаттама      | Code No./Номер кода/Код нөмірі | QTY/Кол-во/Мөлшері |
|-----------------|-------------------------------------|--------------------------------|--------------------|
| 1               | Handle/Ручка/Түтқа                  | H784                           | 1                  |
| 2               | Cartridge/Картридж/Картридж         | 40H-10                         | 1                  |
| 3               | Fixing part/Крепеж/Бекіту бөлігі    | 41038000300                    | 1                  |
| 4               | Neoperl/Аэратор/Аэратор             | 40.0003.000                    | 1                  |
| 5               | Inlet hose/Гибкий шланг/Кіріс шланг | 21450300303                    | 2                  |

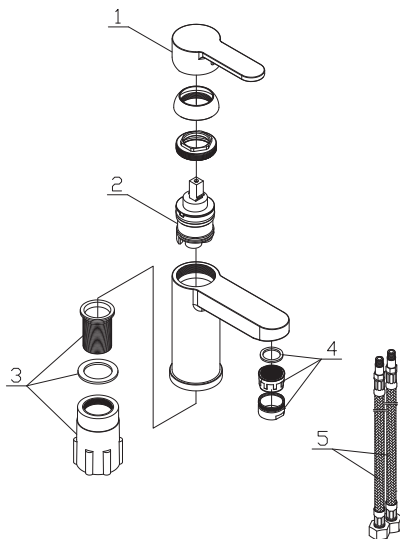

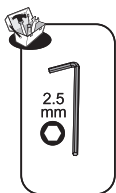

**RU/BY:** Смена картриджа/ **KZ:** Картриджді ауыстыру/  
**EN:** Replacing the cartridge

1



**ВЫКЛ**

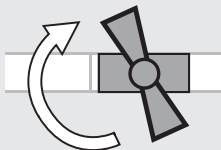

2

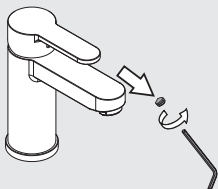

3

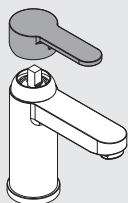

4

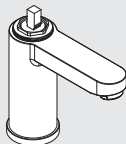

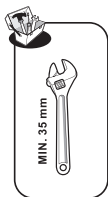

**RU/BY:** Смена картриджа/ **KZ:** Картриджді ауыстыру/  
**EN:** Replacing the cartridge

5

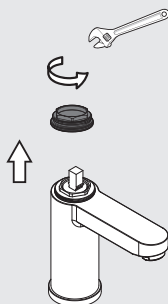

6

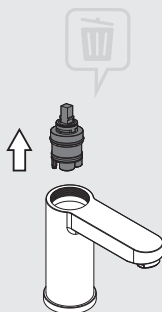

7

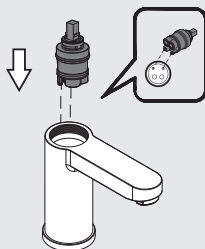

8

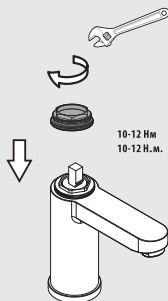



**RU/BY:** Смена картриджа/ **KZ:** Картриджді ауыстыру/  
**EN:** Replacing the cartridge

9

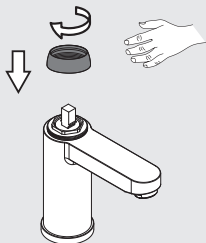

10

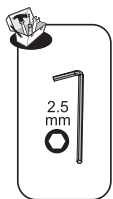
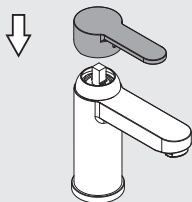

11

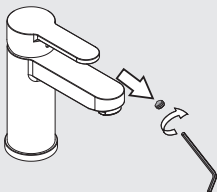

12



**ВКЛ**

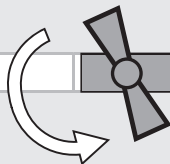

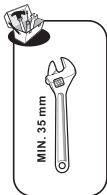

**RU/BY:** Смена аэратора/ **KZ:** Аэратор ауыстыру/ **EN:** Replacing the aerator

1

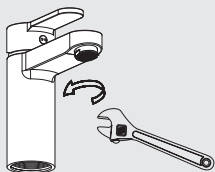

2



**RU**  
**BY**

Чистка

**KZ** тазарту

**EN** Cleaning

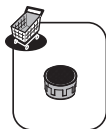

3

**RU**  
**BY**

Уксус

**KZ** Сірке су

**EN** Vinegar

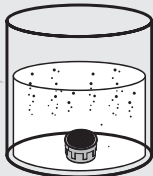

4

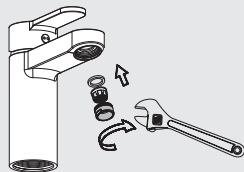

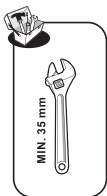

RU/ВУ: Смена гибкого шланга для смесителя/  
KZ: Қоспалауышқа арналған иілгіш шлангты ауыстыру/ EN: Replacing the hoses

1



**ВЫКЛ**

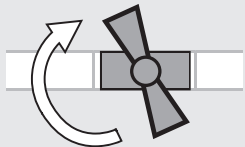

2

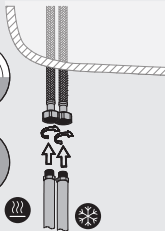

3

**ВКЛ**



4





RU/BY: Смена гибкого шланга для смесителя/  
 KZ: Қоспалауышқа арналған иілгіш шлангты ауыстыру/ EN: Replacing the hoses

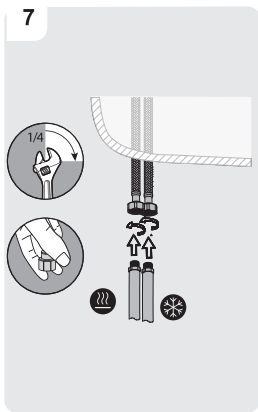
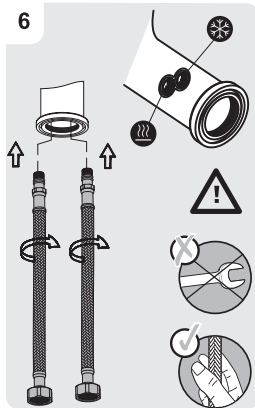
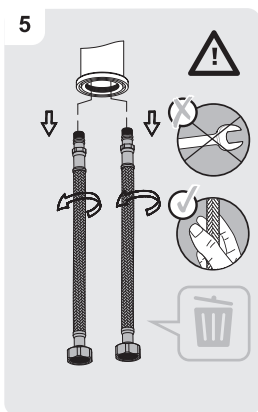



Чистая вода / Таза су / Clean water



Без растворителя / Еріткішсіз / Solvent-free

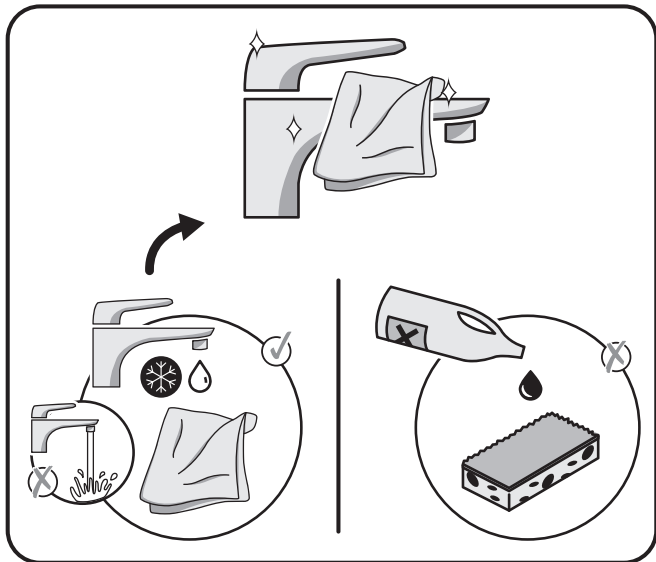











Декларация о соответствии санитарным нормам  
Санитарлық талаптарға сәйкестік декларациясы  
Declaration of sanitary conformity.

\* Кепілдік 5 жыл / Гарантия 5 лет / 5 -year guarantee

Made in P.R.C. 2019

- FR** ADEO Services - 135 Rue Sadi Carnot - CS 00001  
59790 RONCHIN - France
- UA** ТОВ «Леруа Мерлен Україна»,  
вул. Поляна 17а, м. Київ 04201, Україна
- RU** ООО ЛЕРУА МЕРЛЕН ВОСТОК, 141031, Московская  
область, г. Мытищи, Осташковское шоссе, д.1, РОССИЯ
- BY** ООО «Леруа Мерлен Бел», 220020, Республика Беларусь,  
город Минск, проспект Победителей, 100, офис 503

- KZ** Қазақстан Республикасында өнім сапасы бойынша  
наразылықтарды қбылудға уәкілетті ұйым: «Леруа Мерлен  
Қазақстан» ЖШС, Қазақстан Республикасы, 050000,  
Алматы қ., Қонаев көшесі, 77, «PARKVIEW» БО, 6-қабат, 07-кеңсе.  
Организация, уполномоченная принимать претензии по  
качеству продукции в Республике Казахстан: ТОО «Леруа  
Мерлен Казахстан», Республика Казахстан, 050000, г. Алматы,  
ул. Кунаева, 77, БЦ «ParkView», 6 этаж, офис № 07.

