

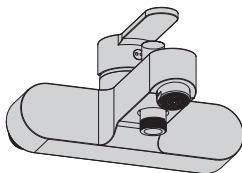

Гарантия
5
лет*

HARMONY

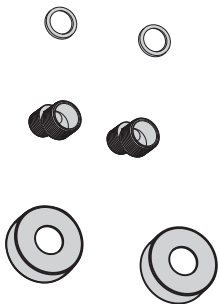

EANCODE:32760070345445

RU Руководство по
BY Эксплуатации

KZ Пайдалану жөніндегі
басшылық

EN Instructions Manual

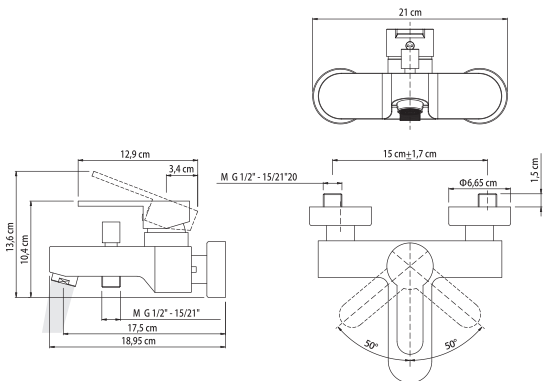

A

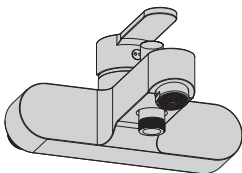

B



C



D



MIN. 35 mm





RU/BY: Подготовка / **KZ:** Дайындау / **EN:** Preparation



4



RU/BY: Сборка / **KZ:** Қурастыру / **EN:** Assembly



5 → 6



RU/BY: Использование горячей и холодной воды/

KZ: Суық және ыстық суды қолдану/ **EN:** Using hot and cold water



7 → 8

RU/BY: Смена картриджа/ **KZ:** Картриджді ауыстыру/ **EN:** Replacing the cartridge



9 → 12

RU/BY: Смена аэратора/ **KZ:** Аэратор ауыстыру/ **EN:** Replacing the aerator



13



RU/ВУ: Подготовка / KZ: Дайындау / EN: Preparation

1

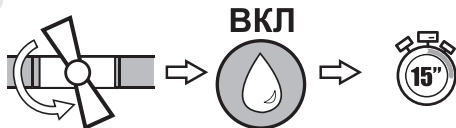

2

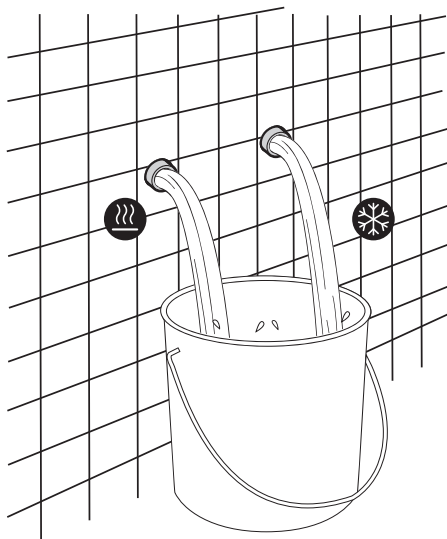

3

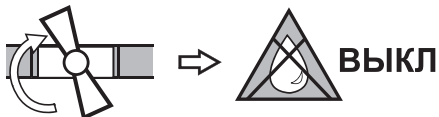



1

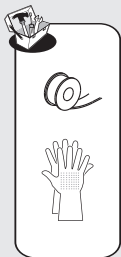
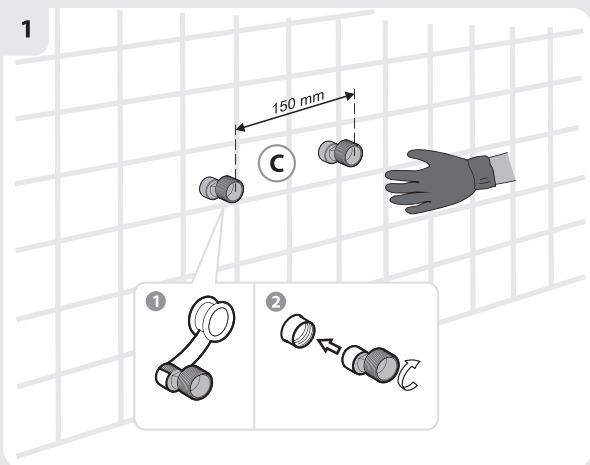

2

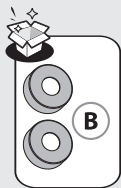
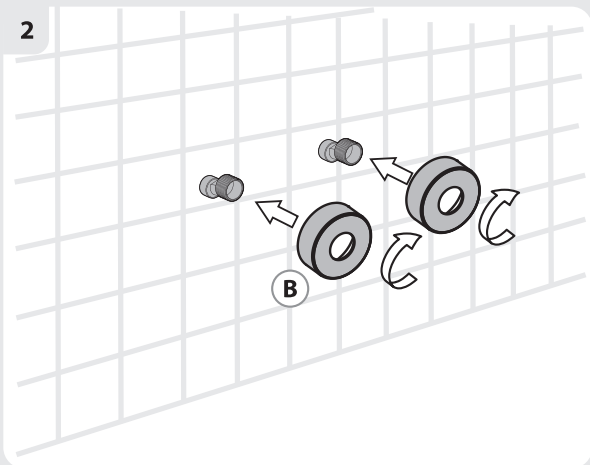



RU/БҮ: Сборка / KZ: Құрастыру / EN: Assembly

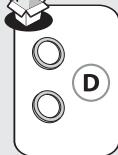

3

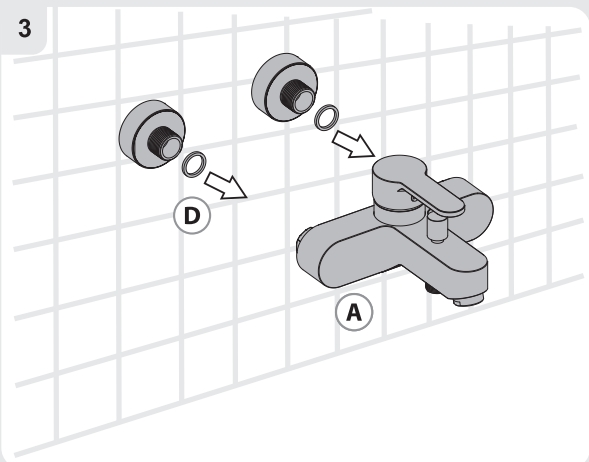

MIN. 35 mm



4

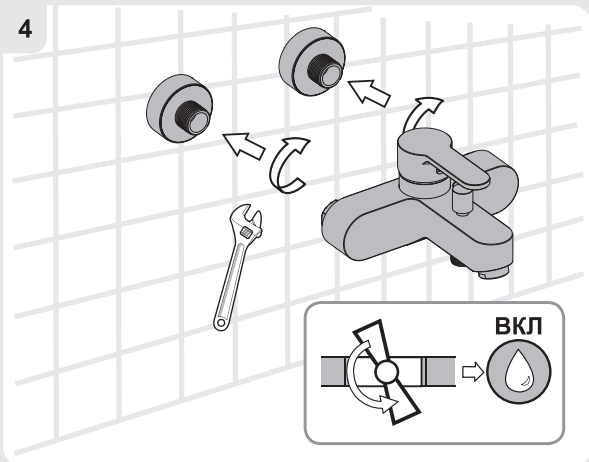



RU/ВУ: Использование горячей и холодной воды/
KZ: Суық және ыстық суды қолдану/ EN: Using hot and cold water

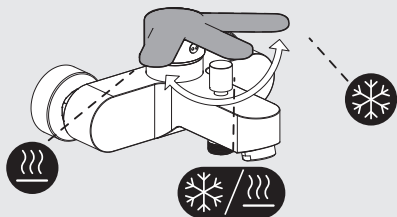
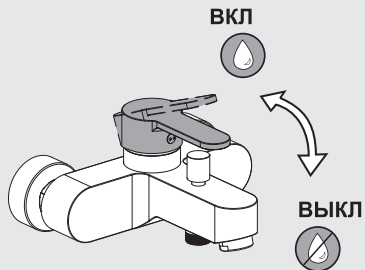



RU/ВУ:Использование горячей и холодной воды/
KZ: Суық және ыстық суды қолдану/ **EN:** Using hot and cold water

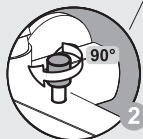
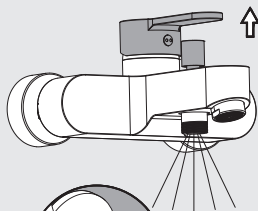
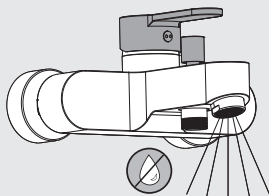

No./Номер/Нөмір	Description/Описание/Сипаттама	Code No./Номер кода/Код нөмірі	QTY/Қол-во/Мөлшері
1	Handle/Ручка/Түтқа	H784	1
2	Cartridge/Картридж/Картридж	T40G-01APX	1
3	Fixing part/Крепеж/Бөкіту бөлігі	2248000300	2
4	Check valve/Переключатель потока/Кері клапан	31.4025.000	1
5	Diverter cap/Крышка отводного патрубка/шағылдырғыш қақпақ	5203	1
6	Neopren/Aэратор/Аэратор	41.0007.000	1
7	Aerator shell/Оболочка аэратора/Аэратор қабығы	73286000900	1

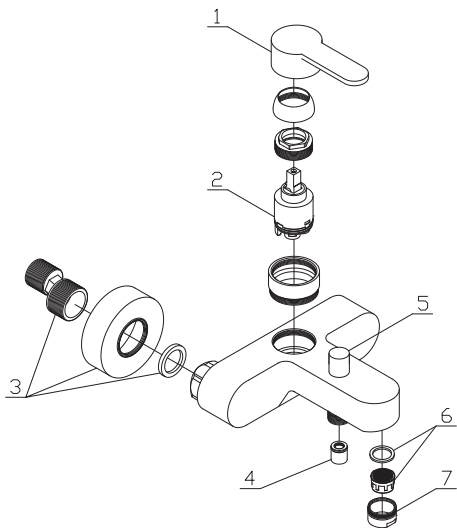

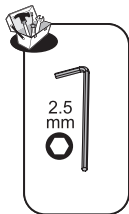

RU/BY: Смена картриджа/ **KZ:** Картриджді ауыстыру/
EN: Replacing the cartridge

1



ВЫКЛ

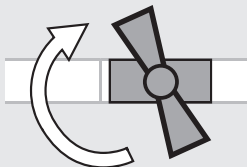

2

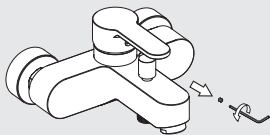

3

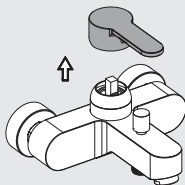

4

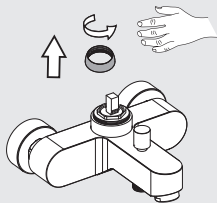

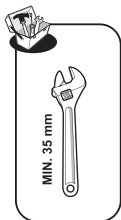

RU/BY: Смена картриджа/ **KZ:** Картриджді ауыстыру/
EN: Replacing the cartridge

5

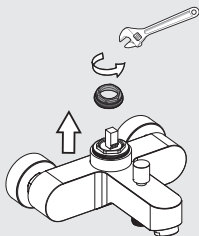

6

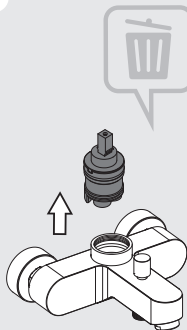

7

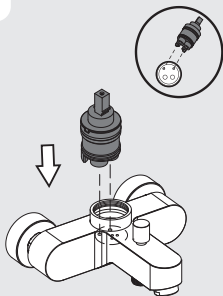

8

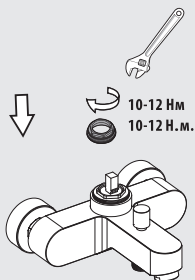



RU/BY: Смена картриджа/ **KZ:** Картриджді ауыстыру/
EN: Replacing the cartridge

9

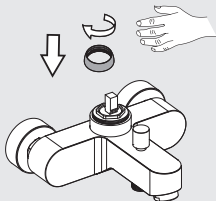

10

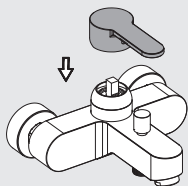

11

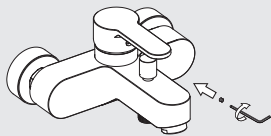

12

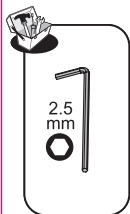

2.5
mm

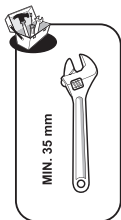

1

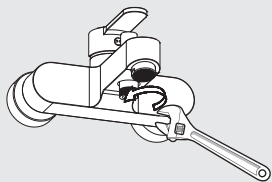

2

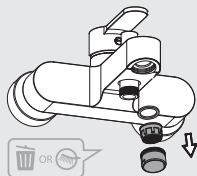

RU

Чистка

БҮ

KZ

тазарту

EN

Cleaning

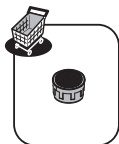

3

RU

Уксус

БҮ

KZ

Сірке су

EN

Vinegar

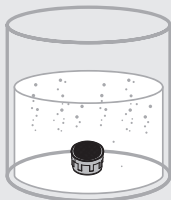

4

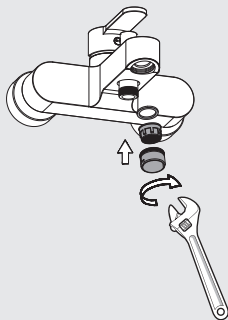



Чистая вода / Таза су / Clean water



Без растворителя / Еріткішсіз / Solvent-free

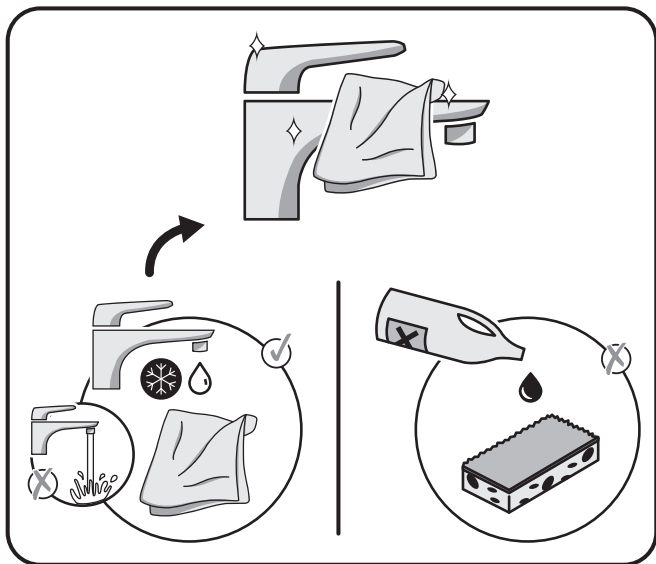



Декларация о соответствии санитарным нормам
Санитарлық талаптарға сәйкестік декларациясы
Declaration of sanitary conformity.

* Кепілдік 5 жыл / Гарантия 5 лет / 5-year guarantee

Made in P.R.C. 2019

FR

ADEO Services - 135 Rue Sadi Carnot - CS 00001
59790 RONCHIN - France

UA

ТОВ «Леруа Мерлен Україна»,
вул. Полярна 17а, м. Київ 04201, Україна

RU

ООО ЛЕРУА МЕРЛЕН ВОСТОК, 141031, Московская
область, г. Мытищи, Осташковское шоссе, д. 1, РОССИЯ

BY

ООО «Леруа Мерлен Бел», 220020, Республика Беларусь,
город Минск, проспект Победителей, 100, офис 503

KZ

Қазақстан Республикасында өнім сапасы бойынша
наразылықтарды қабылдауға уәкілетті ұйым: «Леруа Мерлен
Қазақстан» ЖШС, Қазақстан Республикасы, 050000,
Алматы қ., Қонаев көшесі, 77, «PARKVIEW» БО, 6-қабат, 07-кеңсе.
Организация, уполномоченная принимать претензии по
качеству продукции в Республике Казахстан: ТОО «Леруа
Мерлен Казахстан», Республика Казахстан, 050000, г. Алматы,
ул. Кунаева, 77, БЦ «ParkView», 6 этаж, офис №07.

