

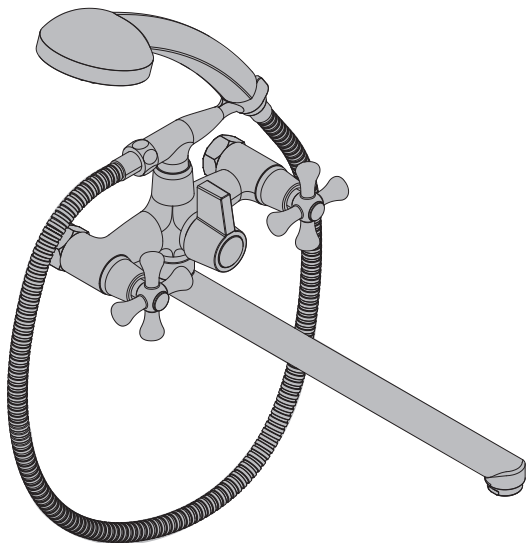

Гарантия
5
лет*

NORIT



EANCODE:3276007035421

RU

Руководство по сборке и эксплуатации

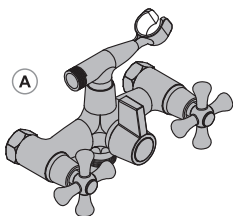
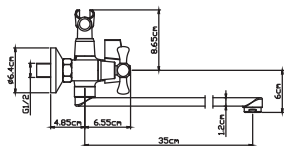
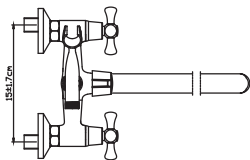

C



E



F

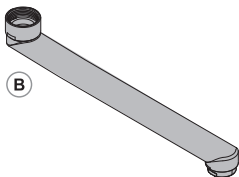

B



D

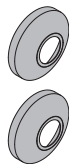

G



MIN. 35 mm





RU: Подготовка



4



RU: Сборка



5 → 11



RU: Использование горячей и холодной воды



12

RU: Смена картриджа



13 → 18

RU: Смена аэратора



19 → 21



RU: Подготовка

1

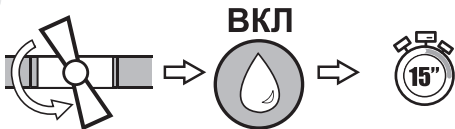

2

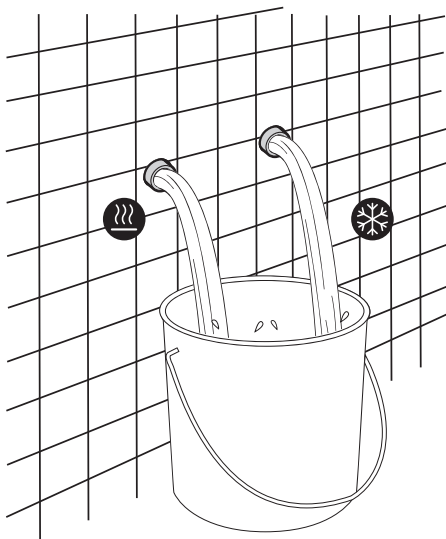

3

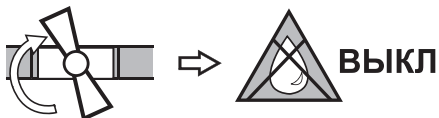



RU : Сборка



1

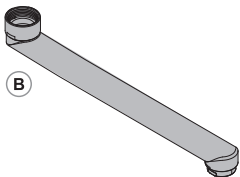
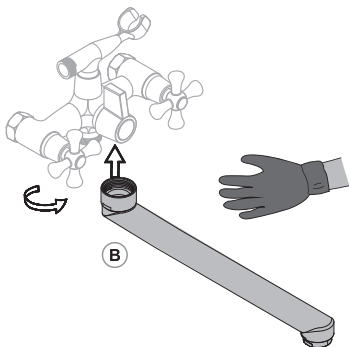

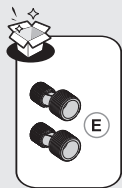

RU: Сборка

1

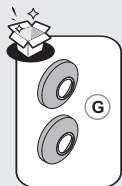
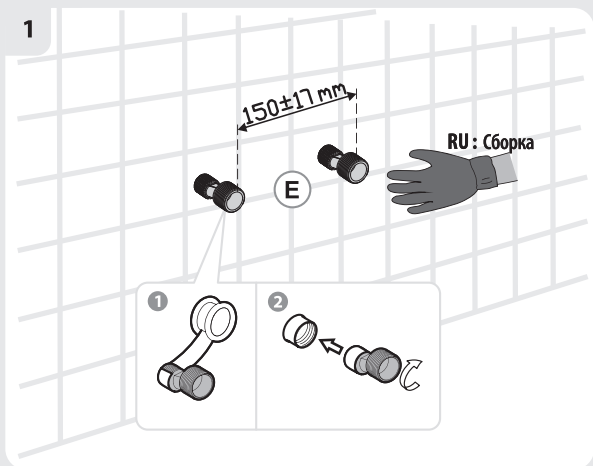
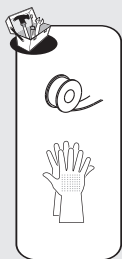

2

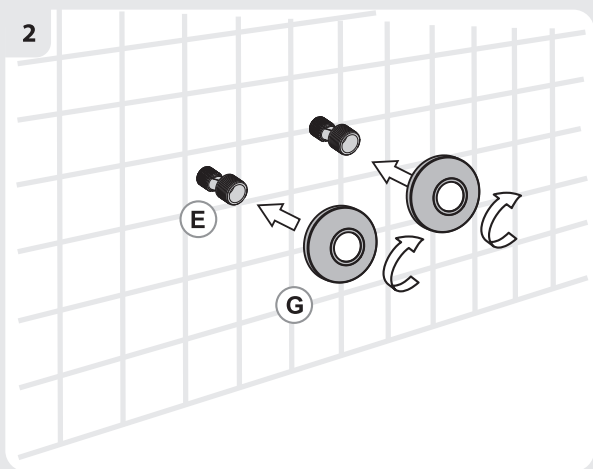

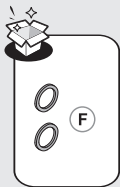

RU: Сборка

3

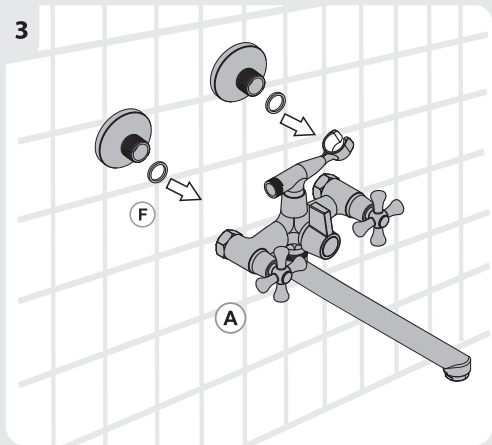

4

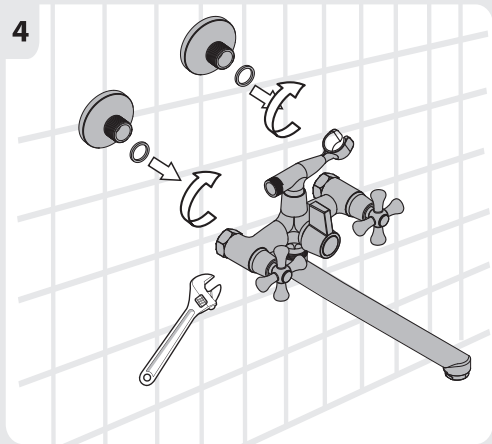

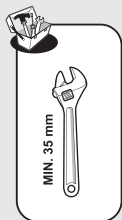

RU : Сборка

5

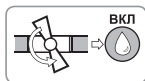
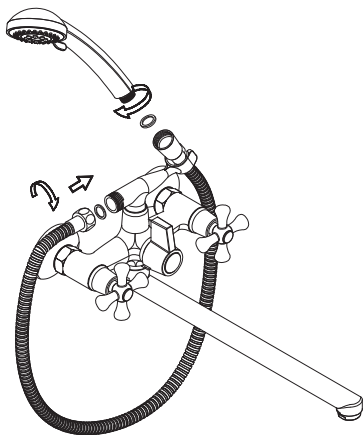

C



D





RU:Использование горячей и холодной воды

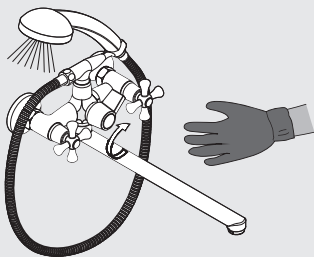
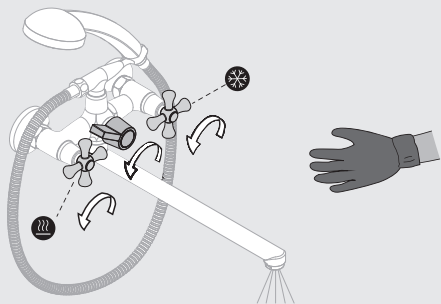

Номер	Описание	Номер зап.	Кол-во
1	Рукоятка	85098003800	2
2	Крышка	55002003300	2
3	Душевой наконечник	91190800353	1
4	ручной душ	F155	1
5	Крышка	22480002300	2
6	Крышка открытого патрубка	85098002900	1
7	шланг	62101003800	1
8	Адаптер	70040022600	1
9	Оболочка адаптера	73240003900	1

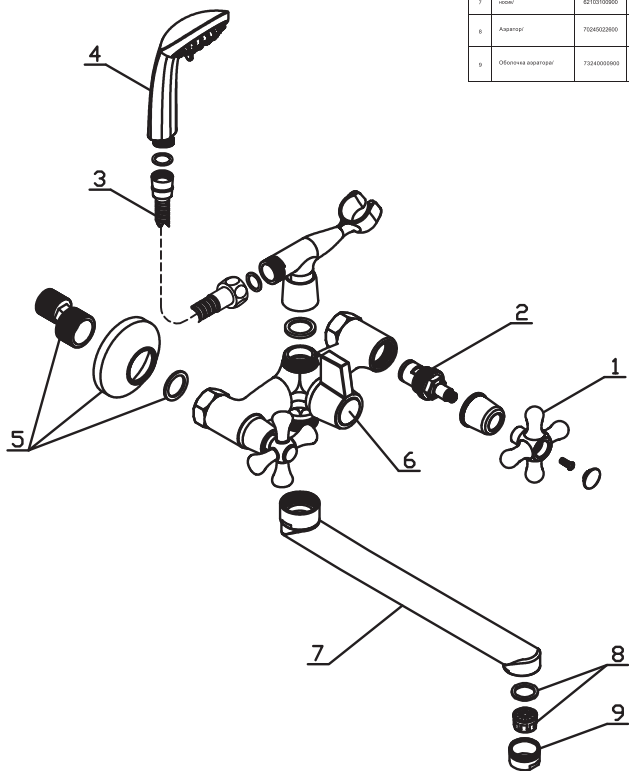

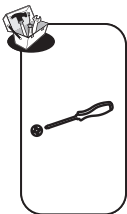

RU: Смена картриджа

1



ВЫКЛ

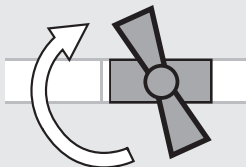

2

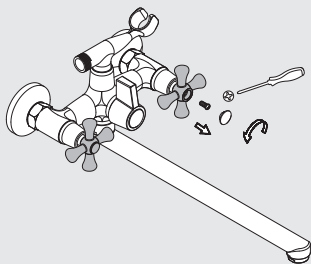



RU: Смена картриджа

3

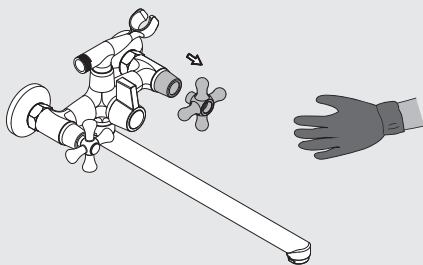

4

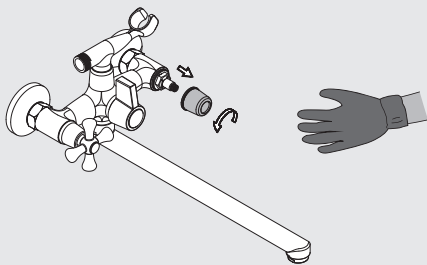

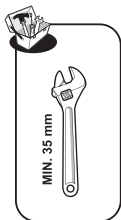

RU: Смена картриджа

5

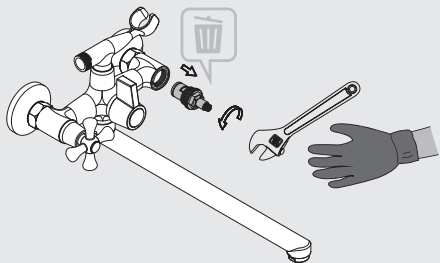

6

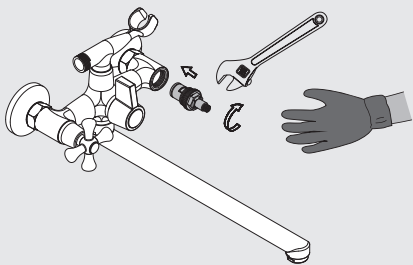



RU: Смена картриджа

7

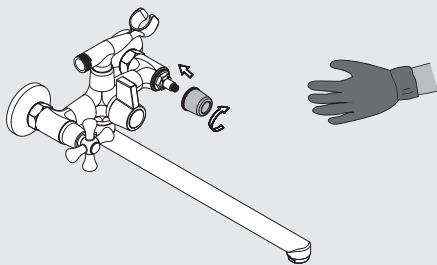

8

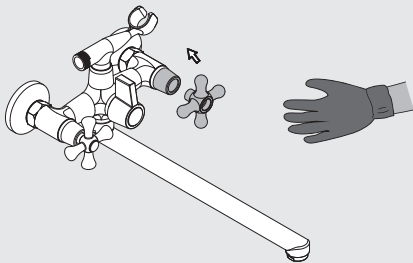

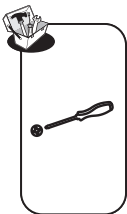

RU: Смена картриджа

9

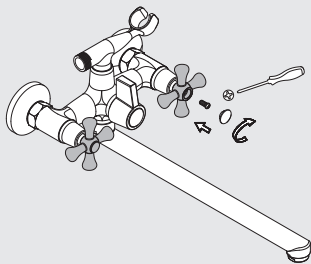

10



ВЫКЛ

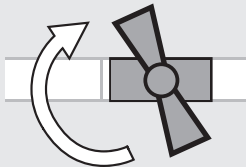

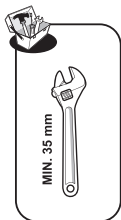

RU: Смена аэратора

1

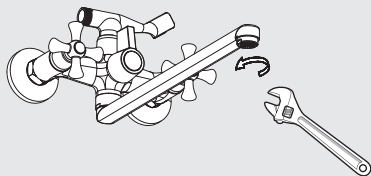

2

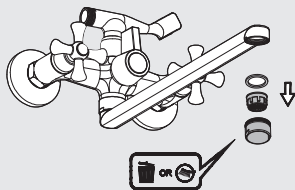



RU: Смена аэратора

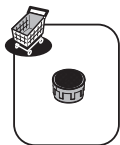

3

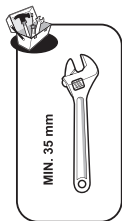
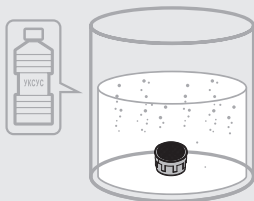

4

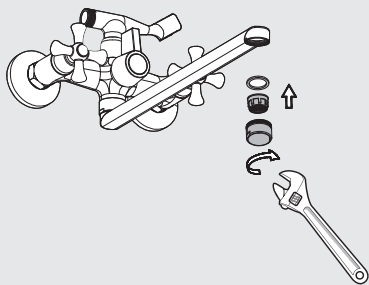



Чистая вода



Без растворителя

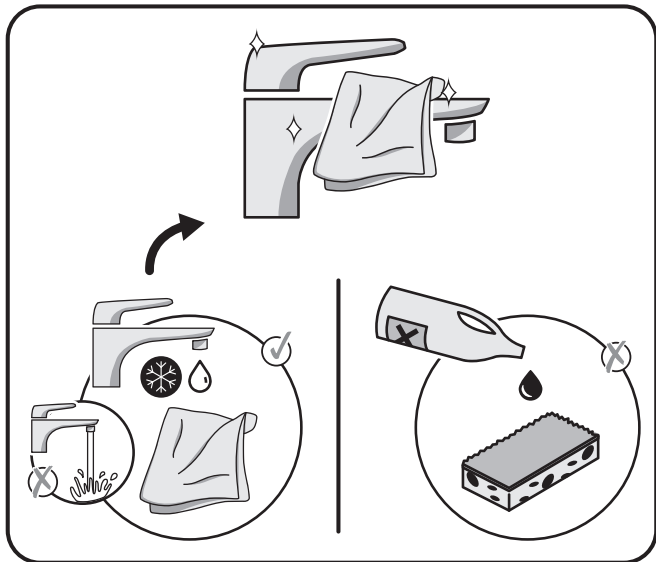



•Гарантия 5 лет

Made in P.R.C. 2019

RU

Импортер/организация, уполномоченная
принимать претензии в РФ:
ООО "Леруа Мерлен Восток",
141031, Россия, Московская обл.,
г. Мытищи, Осташковское шоссе д.1.